

**WARNING:**

This Unit employs Components that tend to produce arcs or sparks – To prevent fire or explosion, do not install in compartments containing batteries or flammable materials - SHOCK HAZARD. DO NOT OPEN.

**CAUTION:**

OUTPUT NON-SINUSOIDAL REFER TO MANUAL - Provided with integral protection against overloads. To prevent fire, do not cover or obstruct ventilation openings. Do not mount in Zero-Clearance compartment. Overheating may result.

**Notice :**

The output of this device is not sinusoidal. It has a total harmonic distortion of 30% percent and maximum single harmonic of 8 percent

---

Toll Free 1 866 295 6775

[www.energizerpower.com](http://www.energizerpower.com)

Printed in China

# ***Energizer***<sup>®</sup>



**EN120**  
**EN180**

Owner's Guide



Conforms to / Conforme à UL std. 458,  
Certified to / Homologué à  
CSA std. C22.2 No. 107.1



## 1 Introduction

Thank you for purchasing the Energizer® EN120/180. Connected to the 12 volt outlet in your vehicle, the EN120/180 efficiently and reliably powers a wide variety of loads through both the AC outlet and USB port.

Read this guide before connecting or using the EN120/180 and save it for future reference.

We hope you enjoy using your EN120/180 and if you require any assistance, please contact our help desk: [www.energizerpower.com](http://www.energizerpower.com) or toll free: 1.866.295.6775

## 2 Important Safety Information

Misusing or incorrectly connecting the EN120/180 may damage the equipment or create hazardous conditions for users. Read the following safety instructions and pay special attention to all Caution and Warning statements in the guide.

**Warnings** identify conditions that may result in personal injury or loss of life.

**Cautions** identify conditions or practices that may damage the unit or other equipment.



### WARNING

Keep children away from the EN120/EN180. The inverter generates the same potentially lethal AC power as a normal household wall outlet.



### Warnings and Cautions

The EN120/EN180 housing may become uncomfortably warm, reaching 140° F (60° C) under extended high power operation. During operation, keep it away from materials that may be affected by high temperatures.

Do not use the EN120/EN180 in the presence of flammable fumes or gases, such as in the bilge of a gasoline powered boat, or near propane tanks. Do not use the EN120/EN180 in an enclosure containing automotive-type lead-acid batteries. These batteries, unlike sealed batteries, vent explosive hydrogen gas, which can be ignited by sparks from electrical connections.



### WARNING: Shock hazard

Use caution when inserting an AC plug into the three-prong AC outlet. The prongs of an AC plug can become bent from misuse. If an AC plug is improperly inserted into the AC outlet, a bent prong can slip outside the inverter and become a shock hazard.

Grip the inverter carefully when inserting or removing an AC plug. Keep your fingers clear of the AC outlet. Ensure that your fingers do not contact the prongs of an AC plug when the plug is partially inside the inverter.

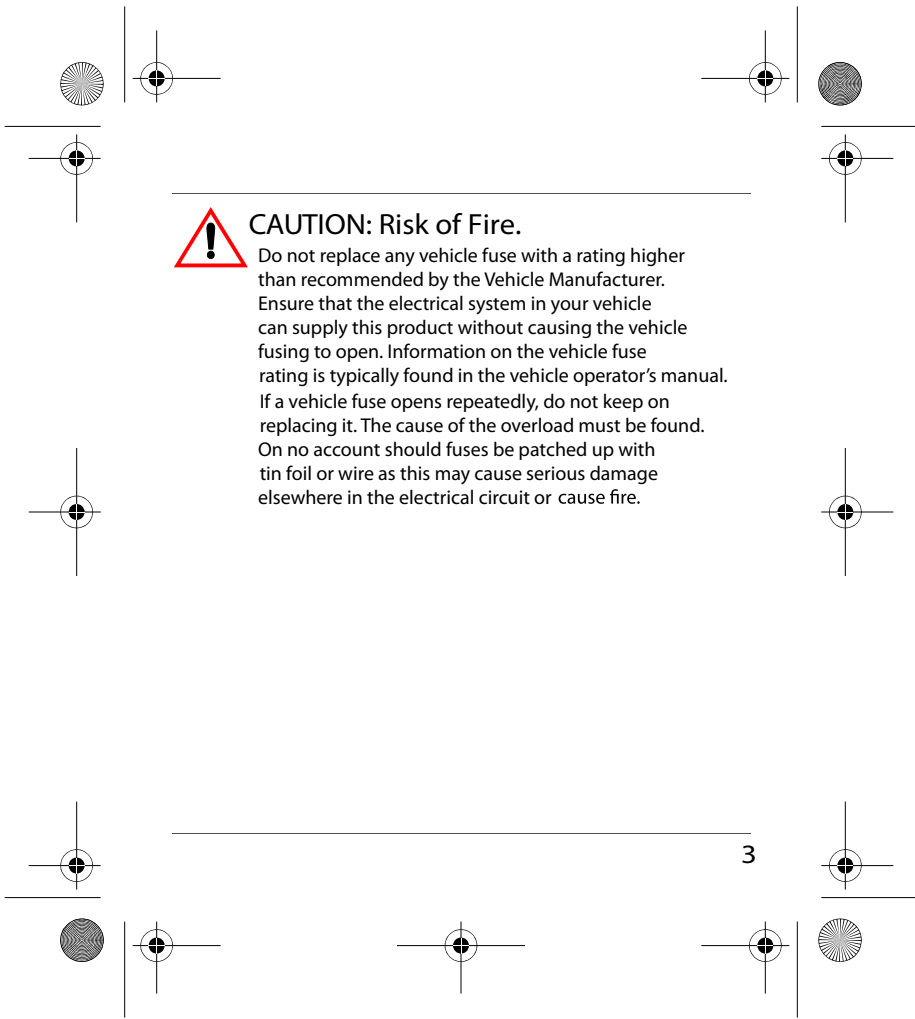

**CAUTION: Risk of Fire.**

Do not replace any vehicle fuse with a rating higher than recommended by the Vehicle Manufacturer. Ensure that the electrical system in your vehicle can supply this product without causing the vehicle fusing to open. Information on the vehicle fuse rating is typically found in the vehicle operator's manual. If a vehicle fuse opens repeatedly, do not keep on replacing it. The cause of the overload must be found. On no account should fuses be patched up with tin foil or wire as this may cause serious damage elsewhere in the electrical circuit or cause fire.

3

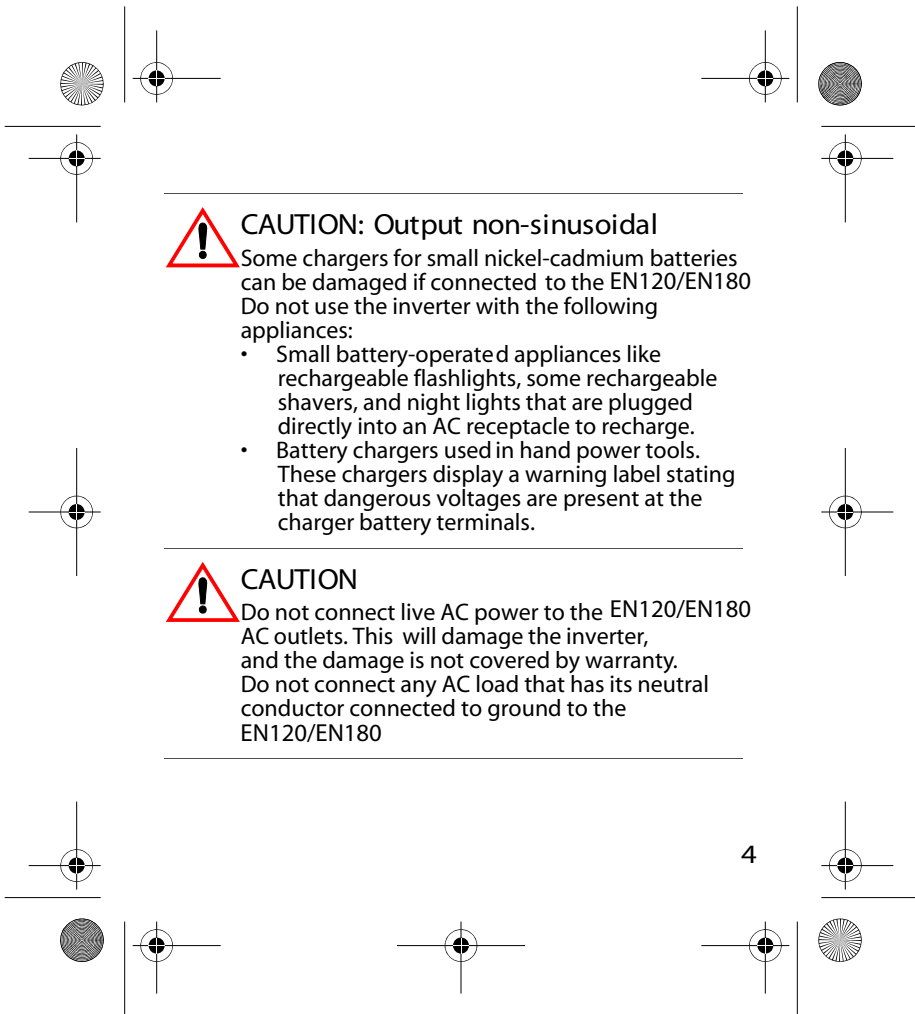

**CAUTION: Output non-sinusoidal**

Some chargers for small nickel-cadmium batteries can be damaged if connected to the EN120/EN180. Do not use the inverter with the following appliances:

- Small battery-operated appliances like rechargeable flashlights, some rechargeable shavers, and night lights that are plugged directly into an AC receptacle to recharge.
- Battery chargers used in hand power tools. These chargers display a warning label stating that dangerous voltages are present at the charger battery terminals.



**CAUTION**

Do not connect live AC power to the EN120/EN180 AC outlets. This will damage the inverter, and the damage is not covered by warranty. Do not connect any AC load that has its neutral conductor connected to ground to the EN120/EN180.

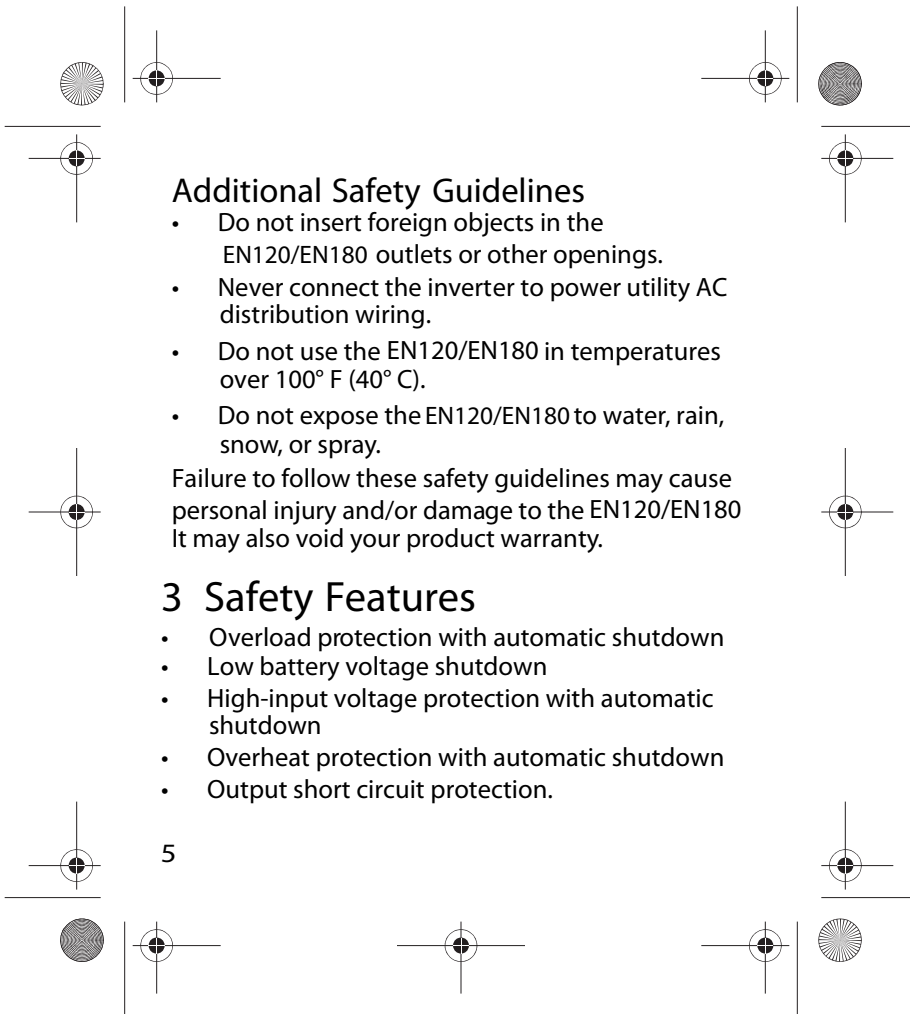

### Additional Safety Guidelines

- Do not insert foreign objects in the EN120/EN180 outlets or other openings.
- Never connect the inverter to power utility AC distribution wiring.
- Do not use the EN120/EN180 in temperatures over 100° F (40° C).
- Do not expose the EN120/EN180 to water, rain, snow, or spray.

Failure to follow these safety guidelines may cause personal injury and/or damage to the EN120/EN180. It may also void your product warranty.

### 3 Safety Features

- Overload protection with automatic shutdown
- Low battery voltage shutdown
- High-input voltage protection with automatic shutdown
- Overheat protection with automatic shutdown
- Output short circuit protection.

## 4 Inverter Features

**Energizer** EN120/180

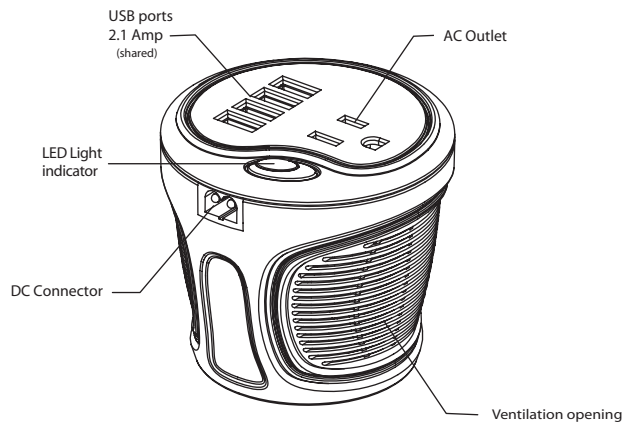

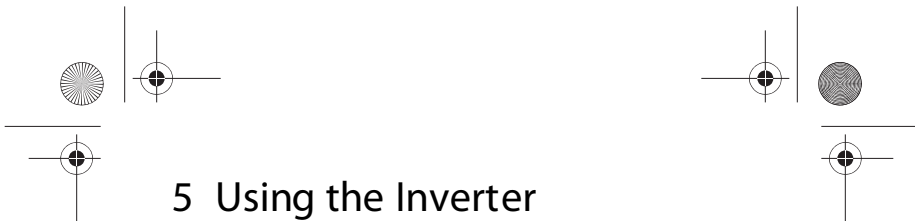

## 5 Using the Inverter

Through its AC outlet, the EN120/180 is capable of powering most 120V AC products that use 120W/180W or less. The EN120/180 can also power or charge most consumer electronics that have USB power ports.

The EN120/180 AC output waveform, called "modified sine wave" is designed to function similarly to the sine wave shape of utility power. Most devices are not affected by a "modified sine wave", you may need to consult with the manufacture of the device you wish to run prior to connection with inverter.

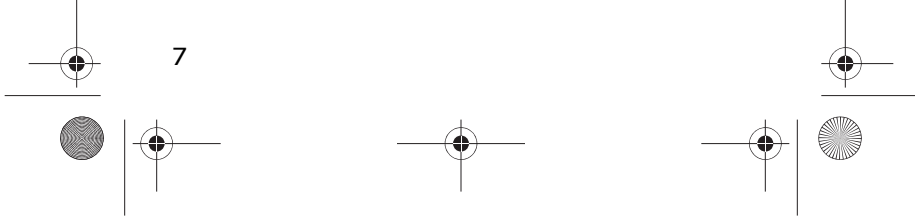
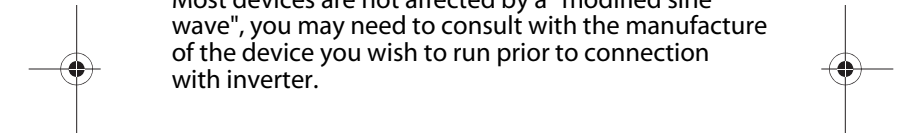



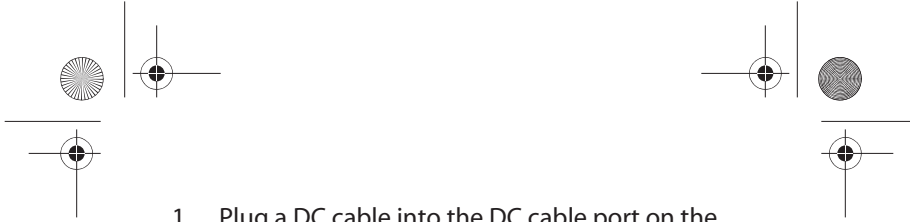

1. Plug a DC cable into the DC cable port on the EN120/180 and connect to a 12V cigarette lighter receptacle.

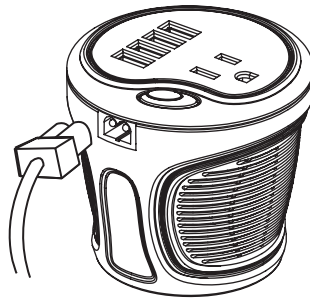

2. Plug the device you want to operate into the EN120/180
3. When the inverter is not in use, unplug it from the 12V outlet to prevent slight discharge of the battery.

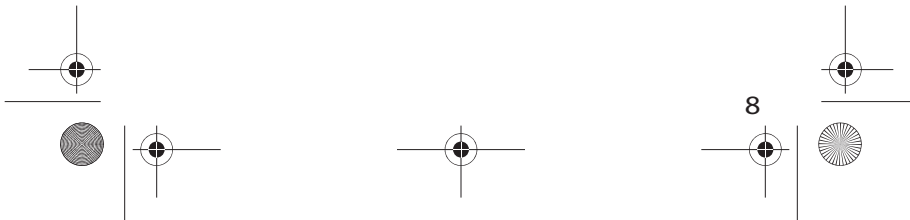

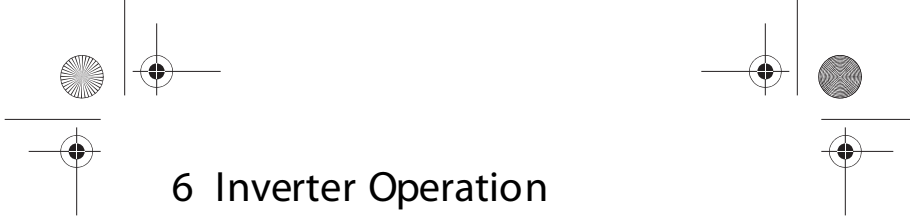

## 6 Inverter Operation

1. When properly connected to a 12V outlet, the light will glow GREEN, indicating the inverter is ready.
2. Plug the product(s) you want to operate into the AC outlet or USB port and switch them on (if necessary).



### Operating Guidelines

- As the battery is used, its voltage begins to fall. When the EN120/180 senses that the voltage at its DC input has dropped to 10.5V, the inverter automatically shuts down and the light glows RED, indicating a fault. This prevents the battery from being damaged. Turn off any devices that the EN120/180 is powering.

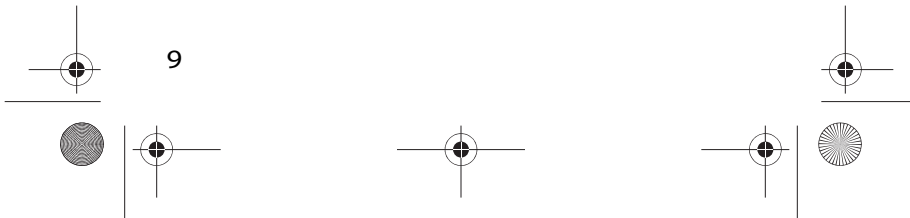

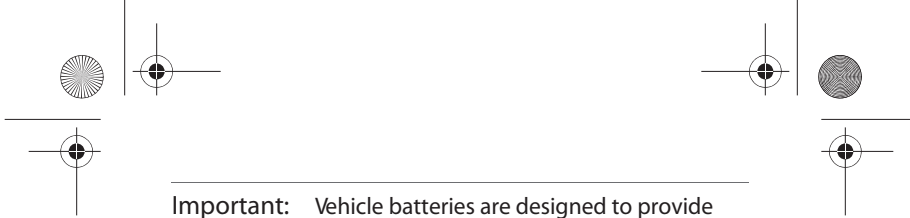

**Important:** Vehicle batteries are designed to provide brief periods of very high current needed for engine starting. They are not intended for constant deep discharge. Regularly operating the EN120/180 from a vehicle battery until low-voltage shutdown occurs will shorten the life of the battery.

- If an AC product rated higher than 120W/180W is plugged into the EN120/180, the inverter will shut down. The LED light will alternate from GREEN to RED continuously.
- If the EN 120/180 exceeds a safe operating temperature, due to insufficient ventilation or a high-temperature environment, it automatically shuts down. The RED FAULT light comes on.
- Should a defective battery charging system cause the battery voltage to rise to dangerously high levels, the EN 120/180 automatically shuts down. The RED FAULT light comes on.

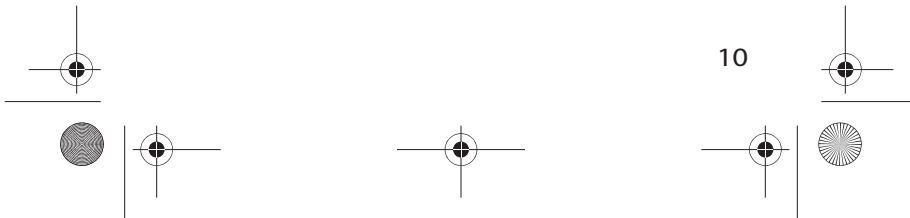



### CAUTION

Although the EN120/180 incorporates protection against over-voltage, it may still be damaged if the input voltage exceeds 16 V.

- In the event of an overload, low battery voltage or overheating, the EN120 /EN 180 automatically shuts down.

### Battery Operating Time

Operating time will vary depending on the charge level of the battery, its capacity and the power level drawn by the particular AC load, USB load, or combination of both. With a typical vehicle battery and a 80W load, an operating time of 4 to 5 hours or more can be expected.

When using a vehicle battery as a power source, it is strongly recommended to start the vehicle every hour or two to recharge the battery before its capacity drops too low. The EN120/180 can operate while the engine is running, but the normal voltage drop that occurs during starting of the engine may trigger the inverter's low voltage shutdown feature.

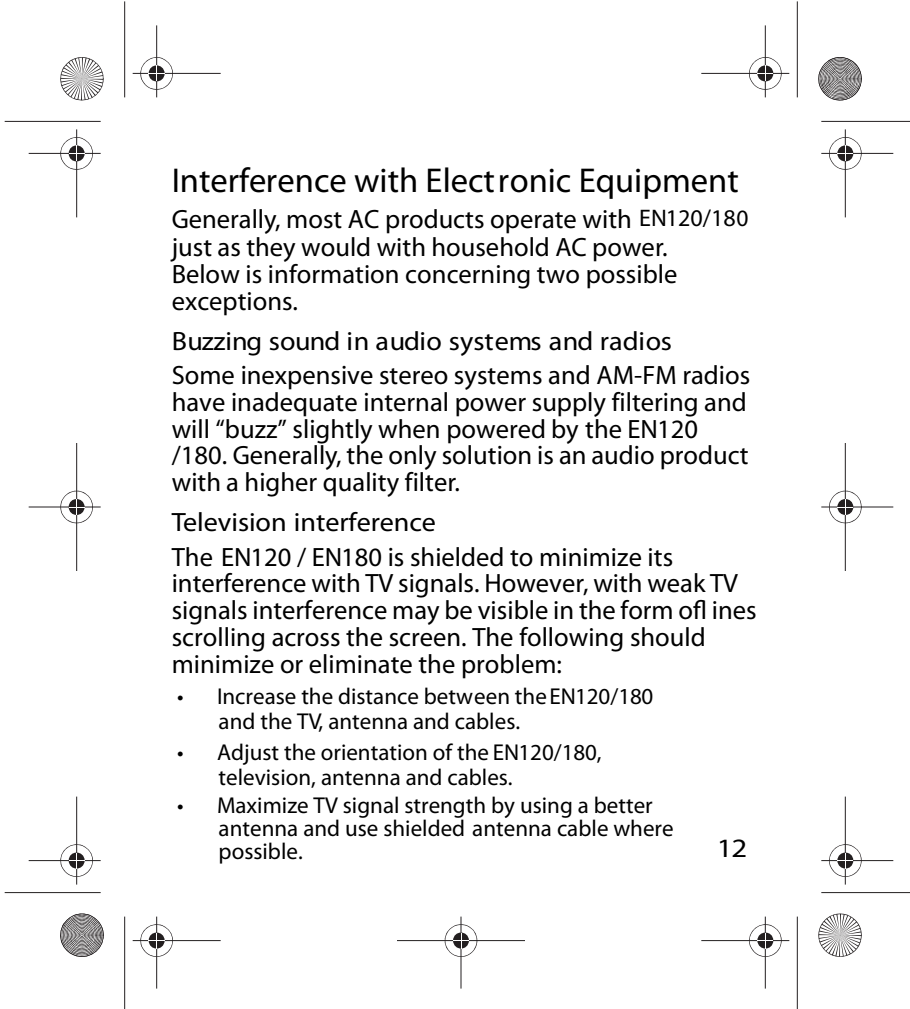

## Interference with Electronic Equipment

Generally, most AC products operate with EN120/180 just as they would with household AC power. Below is information concerning two possible exceptions.

### Buzzing sound in audio systems and radios

Some inexpensive stereo systems and AM-FM radios have inadequate internal power supply filtering and will "buzz" slightly when powered by the EN120 /180. Generally, the only solution is an audio product with a higher quality filter.

### Television interference

The EN120 / EN180 is shielded to minimize its interference with TV signals. However, with weak TV signals interference may be visible in the form of lines scrolling across the screen. The following should minimize or eliminate the problem:



- Increase the distance between the EN120/180 and the TV, antenna and cables.
- Adjust the orientation of the EN120/180, television, antenna and cables.
- Maximize TV signal strength by using a better antenna and use shielded antenna cable where possible.



## 7 Troubleshooting



PROBLEM: AC product will not operate, no inverter lights are ON.

Possible cause	Solution
Battery is defective.	Check battery and replace if required.
Loose connections.	Check connections.



PROBLEM: Measured inverter output is too low.

Possible cause	Solution
Standard "average-reading" AC voltmeter used to measure output voltage, resulting in an apparent reading 5 to 15 V too low.	Inverter's "modified sine wave" output requires "true RMS" voltmeter for accurate measurements.



Possible cause	Solution
Battery voltage is too low.	Recharge battery.
<b>PROBLEM: AC product will not operate, RED FAULT light ON.</b>	
Possible cause	Solution
AC product(s) connected are rated at more than the inverter's continuous power rating; overload shutdown has occurred.	Use a product with a power rating less than the inverter's continuous power rating.
AC product is rated less than the inverter's continuous power rating; high starting surge has caused overload shutdown.	Product exceeds inverter's surge capability. Use a product with starting surge power within the inverter's capability.
Battery is discharged.	Recharge battery.
The inverter has over heated due to poor ventilation and has shut down.	Unplug inverter from DC socket and allow to cool for 15 minutes. Remove objects covering unit. Move the inverter to a cooler place. Reduce load if continuous operation is required. Restart.



## Specifications

Specifications are subject to change without notice.

### AC Power Output

	EN120	EN180
AC output voltage (nominal)	115VAC/60Hz 120W	115VAC/60Hz 180W
Continuous AC output power	120W	180W
AC output waveform	Modified sine wave	
Maximum AC output surge power	240W	360W
AC output frequency	60 ± 3Hz	60 ± 3Hz
USB DC output voltage	5V DC	5V DC
4X USB DC output current (max.)	2.1 Amp <small>(Shared)</small>	2.1 Amp <small>(Shared)</small>

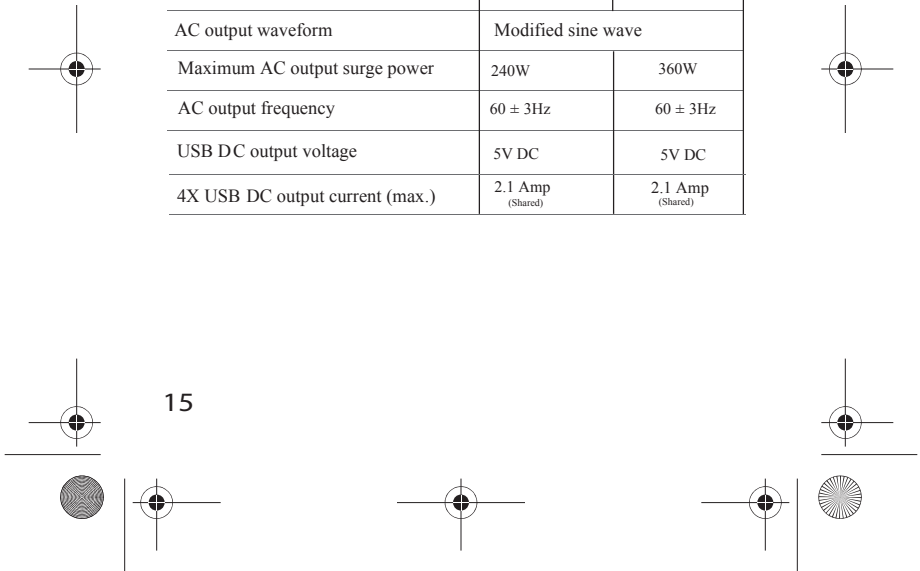



The page is framed by registration marks consisting of crosshairs and circular patterns at the corners and midpoints of the edges.

## DC Power Specifications

	EN120	EN180
DC input voltage range (VDC)	13.8V DC, 10A Max	13.8V DC, 15A Max
Battery drain with no AC load (at 12 V input)	0.4A	0.4A
Efficiency (maximum)	85%	85%
Low voltage shutdown point (nominal)	10.5V $\pm$ 0.5V	10.5V $\pm$ 0.5V
High voltage shutdown point (nominal)	15.5V $\pm$ 0.3V	15.5V $\pm$ 0.3V

## Physical Specifications

Dimensions (inches) (Length $\times$ Width $\times$ Height)	(L)3.3 (W)3.26 (H)3	(L)3.3 (W)3.26 (H)3
Weight	0.42 lbs	0.44 lbs

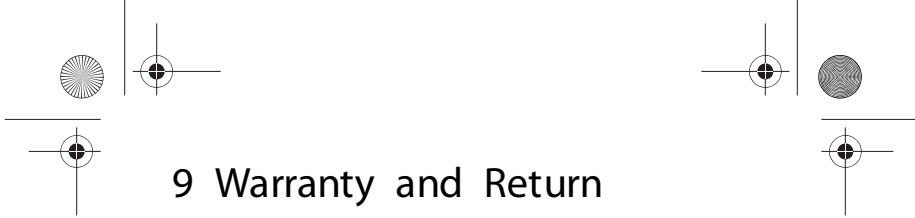

## 9 Warranty and Return

### Warranty by PowerBright

**What does this warranty cover?**

This Limited Warranty is provided by PowerBright and covers defects in workmanship and materials in your EN120/180. This warranty period lasts for 24 months from the date of purchase at the point of sale to you, the original end user customer. You require proof of purchase to make warranty claims.

**What will PowerBright do?** PowerBright will, at its option, repair or replace the defective product free of charge, provided that you notify PowerBright of the product defect within the Warranty Period, and provided that PowerBright through inspection establishes the existence of such a defect and that it is covered by this Limited Warranty.

PowerBright will, at its option, use new and/or reconditioned parts in performing warranty repair and building replacement products. PowerBright reserves the right to use parts or products of original or improved design in the repair or replacement. If PowerBright repairs or replaces a product, its warranty continues for the remaining portion of the original Warranty Period or 90 days from the date of the return

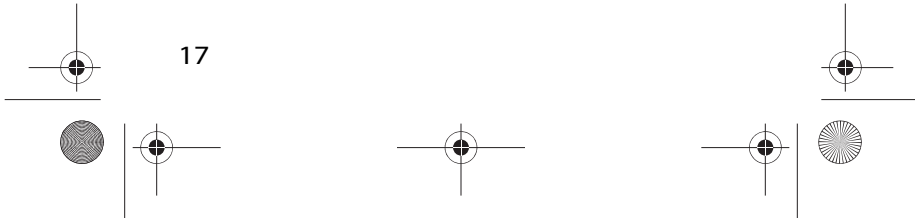



shipment to the customer, whichever is greater. All replaced products and all parts removed from repaired products become the property of PowerBright.

PowerBright covers both parts and labor necessary to repair the product, and return shipment to the customer via a PowerBright selected non-expedited surface freight within the contiguous United States and Canada. Alaska and Hawaii are excluded. Contact PowerBright Customer Service for details on freight policy for return shipments outside of the contiguous United States and Canada.

**How do you get service?**

If your product requires troubleshooting or warranty service, contact your dealer. If you are unable to contact your dealer, or the dealer is unable to provide service, contact PowerBright directly at:

Toll Free: 1 866 295 6775  
Website: [www.PowerBright.com](http://www.PowerBright.com)

Direct returns may be performed according to the PowerBright Return Material Authorization Policy described in your product manual. For some products, PowerBright maintains a network of regional Authorized Service Centers. Call PowerBright or check our website to see if your product can be repaired at one of these facilities.

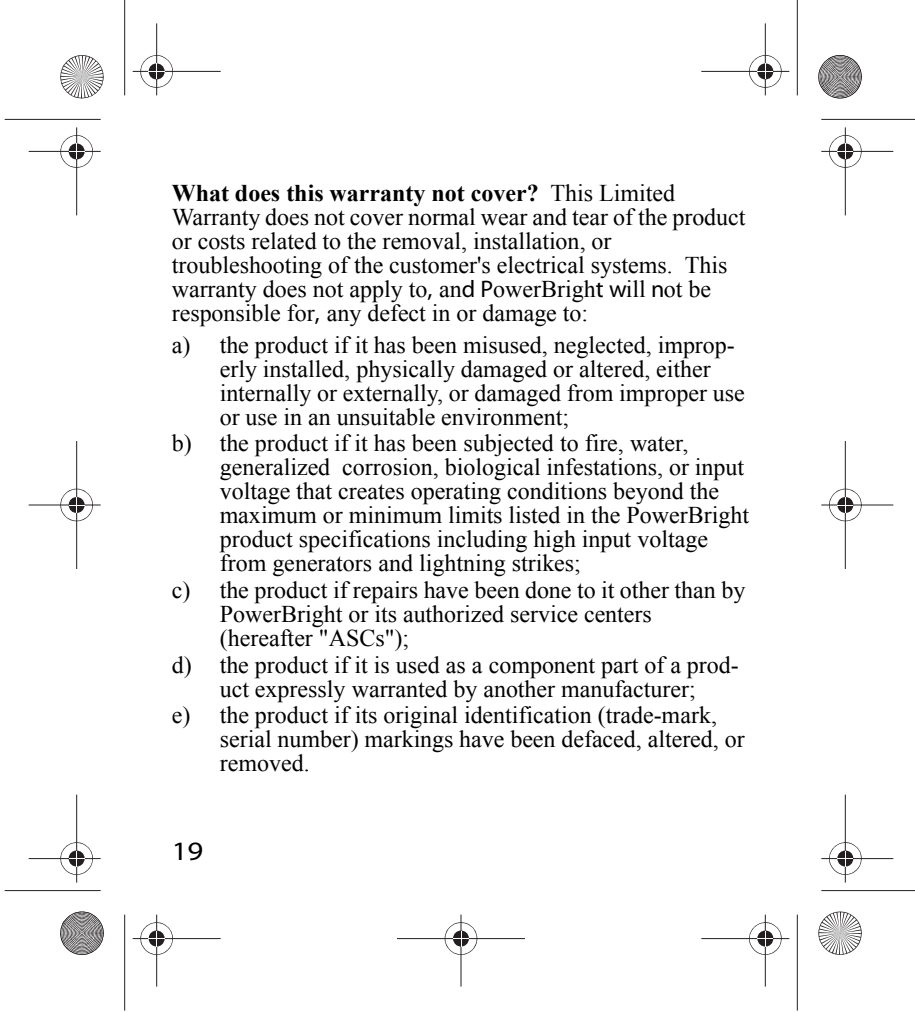

**What does this warranty not cover?** This Limited Warranty does not cover normal wear and tear of the product or costs related to the removal, installation, or troubleshooting of the customer's electrical systems. This warranty does not apply to, and PowerBright will not be responsible for, any defect in or damage to:

- a) the product if it has been misused, neglected, improperly installed, physically damaged or altered, either internally or externally, or damaged from improper use or use in an unsuitable environment;
- b) the product if it has been subjected to fire, water, generalized corrosion, biological infestations, or input voltage that creates operating conditions beyond the maximum or minimum limits listed in the PowerBright product specifications including high input voltage from generators and lightning strikes;
- c) the product if repairs have been done to it other than by PowerBright or its authorized service centers (hereafter "ASCs");
- d) the product if it is used as a component part of a product expressly warranted by another manufacturer;
- e) the product if its original identification (trade-mark, serial number) markings have been defaced, altered, or removed.

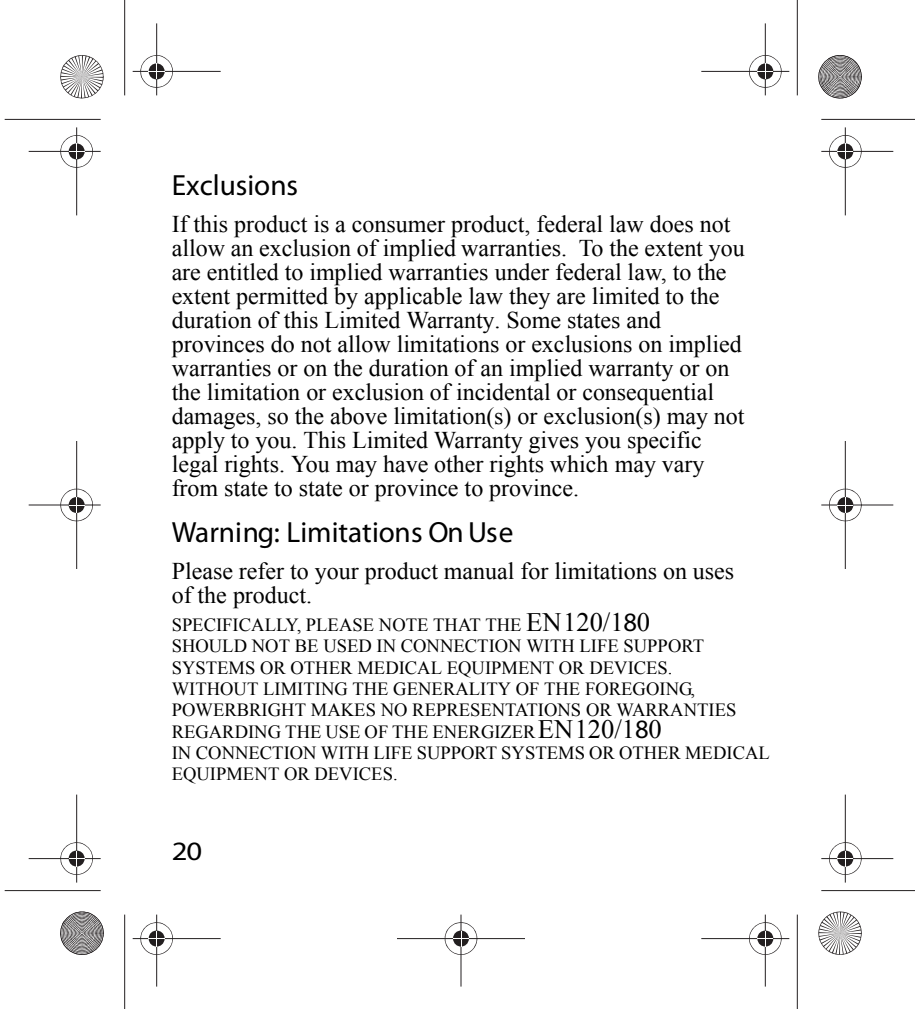

### Exclusions

If this product is a consumer product, federal law does not allow an exclusion of implied warranties. To the extent you are entitled to implied warranties under federal law, to the extent permitted by applicable law they are limited to the duration of this Limited Warranty. Some states and provinces do not allow limitations or exclusions on implied warranties or on the duration of an implied warranty or on the limitation or exclusion of incidental or consequential damages, so the above limitation(s) or exclusion(s) may not apply to you. This Limited Warranty gives you specific legal rights. You may have other rights which may vary from state to state or province to province.

### Warning: Limitations On Use

Please refer to your product manual for limitations on uses of the product.

**SPECIFICALLY, PLEASE NOTE THAT THE EN 120/180 SHOULD NOT BE USED IN CONNECTION WITH LIFE SUPPORT SYSTEMS OR OTHER MEDICAL EQUIPMENT OR DEVICES. WITHOUT LIMITING THE GENERALITY OF THE FOREGOING, POWERBRIGHT MAKES NO REPRESENTATIONS OR WARRANTIES REGARDING THE USE OF THE ENERGIZER EN 120/180 IN CONNECTION WITH LIFE SUPPORT SYSTEMS OR OTHER MEDICAL EQUIPMENT OR DEVICES.**

## Return Material Authorization Policy

Before returning a product directly to PowerBright you must obtain a Return Material Authorization (RMA) number and the correct factory "Ship To" address. Products must also be shipped prepaid. Product shipments will be refused and returned at your expense if they are unauthorized, returned without an RMA number clearly marked on the outside of the shipping box, if they are shipped collect, or if they are shipped to the wrong location.

When you contact PowerBright to obtain service, please have your instruction manual ready for reference and be prepared to supply:

- The serial number of your product
- Information about the installation and use of the unit
- Information about the failure and/or reason for the return
- A copy of your dated proof of purchase

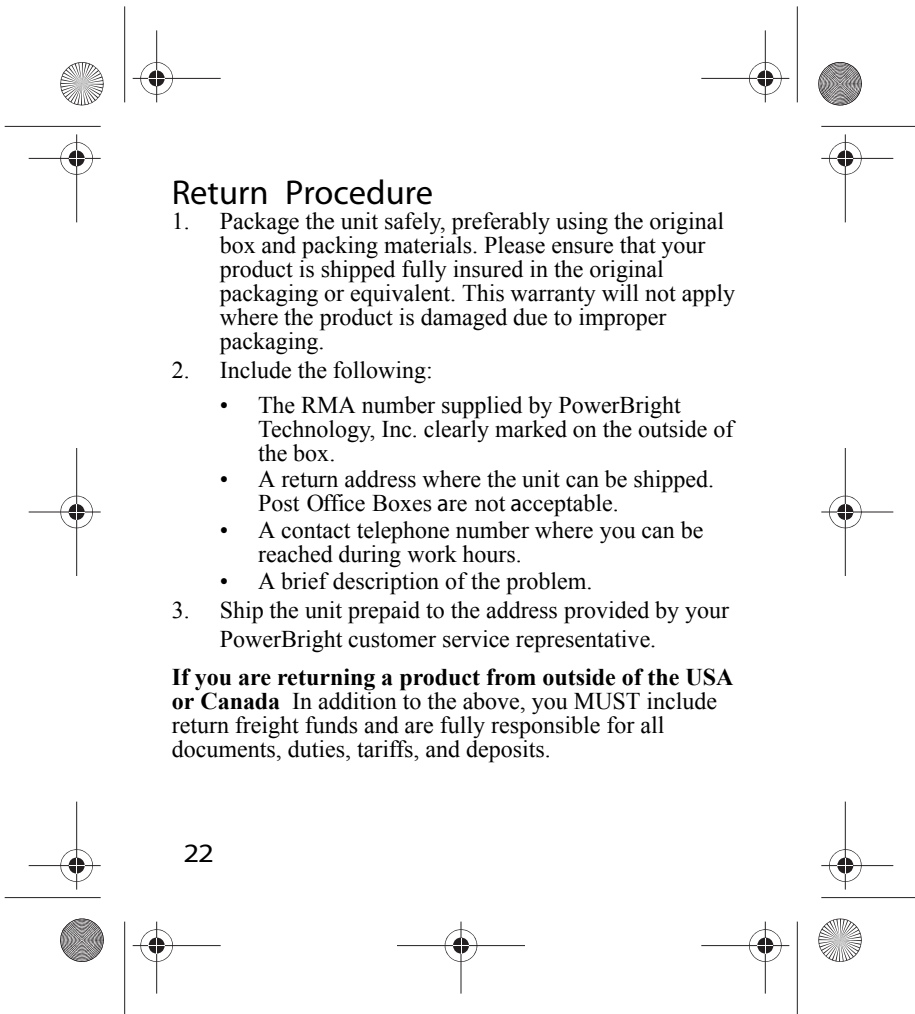

### Return Procedure

1. Package the unit safely, preferably using the original box and packing materials. Please ensure that your product is shipped fully insured in the original packaging or equivalent. This warranty will not apply where the product is damaged due to improper packaging.
2. Include the following:
  - The RMA number supplied by PowerBright Technology, Inc. clearly marked on the outside of the box.
  - A return address where the unit can be shipped. Post Office Boxes are not acceptable.
  - A contact telephone number where you can be reached during work hours.
  - A brief description of the problem.
3. Ship the unit prepaid to the address provided by your PowerBright customer service representative.

**If you are returning a product from outside of the USA or Canada** In addition to the above, you **MUST** include return freight funds and are fully responsible for all documents, duties, tariffs, and deposits.